



OUR ANSWER
TO
GLOBAL
WARMING



NEOTECH™

The True Engineers

It is our Pleasure to represent ourselves as a “**NEOTECH™**” Group of Companies (Formerly known as “**Jainson™**”) of the new millennium. **NEOTECH™** had started its industrial activity in the year 1996 on miniscal scale with the development of Pressure Switches for Air Compressors.

With rapid industrialization and automization, group has adopted latest technology to develop Tube Axial Fans. Backed up by excellent engineering know how, supported by German R&D, **NEOTECH™** has developed its core competence in Motor technology, constantly setting new standards in motor and fans technology, thus exceeding the ever growing specialized customer expectations and requirements.

Continuous support from the reputed customers and equal reciprocation by the group by way of introducing new products into the market. This has motivated our group to develop Industrial Relay under the leadership of dynamic Directors of the company Shri Niraj. S. Khemka and Shri Vishal. S. Khemka.

It is a matter of pride that millions of our product Fans, Pressure Switches and Relays are being used by various industries & this has been possible due to our sincere effort to maintain quality standards from time to time to produce better product. Besides R&D Lab we have “In House Test Lab “Which is equipped with modern equipments required to test products parameters e.g. CFM, Bump, Vibration, Humidity, Temperature, Bounce, Operate Release time etc. and of course “Life Test”. We believe in high quality, cost effective and reliable solutions designed for an extensive range of applications, including IT and Telecom, Railways, Automation, Aviation Industries which are renowned internationally.

We have strength of about 200 skilled employees in our well equipped factory develop and produce fans, Pressure Switches and Relays with passionate enthusiasm, striving to create perfect application solutions for an extremely wide variety of industries. What is distinctive about **NEOTECH™** is that we not only mass-produce large product series in high quality, but also fulfill individual customer requests for professional applications.

Those who know us know that we demand the best of ourselves in setting worldwide benchmarks in innovation and close relationships with customers. Day after day, we work to achieve exemplary performance and be the proverbial “one step ahead” of the competition by virtue of our technologies, our superior skills and knowledge in respective product line.

We are indeed delighted to inform you that our entire range of “**NEOTECH™**” INSTRUMENT COOLING FANS” is “**CE**” approved.

We distribute our products through our dealer and distributor network in India. Our dealers are equipped with product brochures, technical data, promotional material, etc. We also support them with technical information as and when required for specialized applications.



Price List W.E.F. 7th OCTOBER 2021 AC AXIAL FAN

MODEL NO.	BEARING TYPE	VOLTAGE	PRICE	STD PACKING
J-22038 S1 H	SLEEVE BEARING	110VAC	714.00	40
J-22038 B1 H	BALL BEARING	110VAC	865.00	40
J-22038 S2 H	SLEEVE BEARING	230VAC	476.00	40
J-22038 B2 H	BALL BEARING	230VAC	625.00	40
J-22038 S24	SLEEVE BEARING	24VAC	910.00	40
J-22038 B24	BALL BEARING	24VAC	990.00	40

4" FAN
120 x 120 x 38 mm

CE



MODEL NO.	BEARING TYPE	VOLTAGE	PRICE	STD PACKING
J-17252 S1 H	SLEEVE BEARING	110VAC	1410.00	24
J-17252 B1 H	BALL BEARING	110VAC	1520.00	24
J-17252 S2 H	SLEEVE BEARING	230VAC	1134.00	24
J-17252 B2 H	BALL BEARING	230VAC	1244.00	24

6" OVAL FAN
172 x 150 x 51 mm

CE



MODEL NO.	BEARING TYPE	VOLTAGE	PRICE	STD PACKING
J-17255 S1 H	SLEEVE BEARING	110VAC	1410.00	24
J-17255 B1 H	BALL BEARING	110VAC	1520.00	24
J-17255 S2 H	SLEEVE BEARING	230VAC	1134.00	24
J-17255 B2 H	BALL BEARING	230VAC	1244.00	24

6" SQUARE FAN
172 x 172 x 55 mm

CE



MODEL NO.	BEARING TYPE	VOLTAGE	PRICE	STD PACKING
J-22060 S B1	BALL BEARING	110 VAC	2480.00	12
J-22060 S B2	BALL BEARING	230VAC	1900.00	12

8" SQUARE FAN
220 x 220 x 60 mm

CE



MODEL NO.	BEARING TYPE	VOLTAGE	PRICE	STD PACKING
J-22060 R B1	BALL BEARING	110 VAC	2480.00	12
J-22060 R B2	BALL BEARING	230VAC	1900.00	12

8" ROUND FAN
220 Ø x 60 mm

CE



J-8025A240SH (80X80X25mm)	SLEEVE BEARING	240VAC	525.00	20
J-9225A240SH (92X92X25mm)	SLEEVE BEARING	240VAC	535.00	20



3" FAN
80x80x25mm



3.5" FAN
92x92x25mm

DC BRUSLESS FAN

MODEL NO.	BEARING TYPE	VOLTAGE	PRICE	STD PACKING
8025D12SH	SLEEVE BEARING	12 VDC	235.00	50
8025D24SH	SLEEVE BEARING	24 VDC	242.00	50

3" FAN
80 x 80 x 25 mm

CE



MODEL NO.	BEARING TYPE	VOLTAGE	PRICE	STD PACKING
9225D12SH	SLEEVE BEARING	12 VDC	336.00	50
9225D24SH	SLEEVE BEARING	24 VDC	346.00	50

3.5" FAN
92 x 92 x 25 mm

CE



MODEL NO.	BEARING TYPE	VOLTAGE	PRICE	STD PACKING
12038D12SH	SLEEVE BEARING	12 VDC	540.00	40
12038D24SH	SLEEVE BEARING	24 VDC	568.00	40
12038D48SH	SLEEVE BEARING	48 VDC	588.00	40

4" FAN
120 x 120 x 38 mm

CE



MODEL NO.	BEARING TYPE	VOLTAGE	PRICE	STD PACKING
1725D12BH	BALL BEARING	12 VDC	3255.00	12
1725D24BH	BALL BEARING	24 VDC	2890.00	12

6" OVAL FAN
172 x 150 x 51 mm

CE



PRICE LIST CUM TECHNICAL SPECIFICATION

- Insulation Resistance** : Min. 10M Ohm at 500 VDC between terminal & the frame.
- Operating Temp.** : Ball bearing : Within - 20-80°C. • Sleeve bearing : Within - 10-56°C
- Life Expectancy** : Ball bearing : 50,000 hours at 60°C. • Sleeve bearing : 20,000 hours at 45°C
- Above Measurements** : At temp. Within 20-30°C. • At humidity 65% ±15%

DIMENSION

4" FAN
 120 x 120 x 38 mm

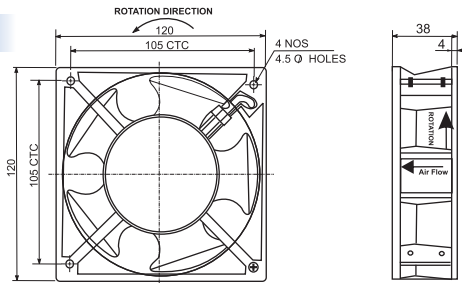

AIR PERFORMANCE

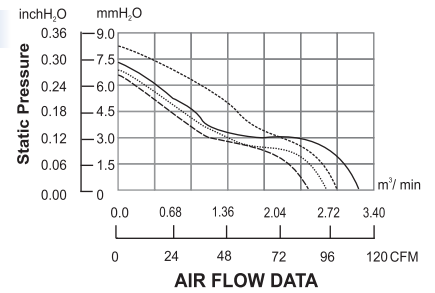

DIMENSION

6" OVAL FAN
 172 x 150 x 51 mm

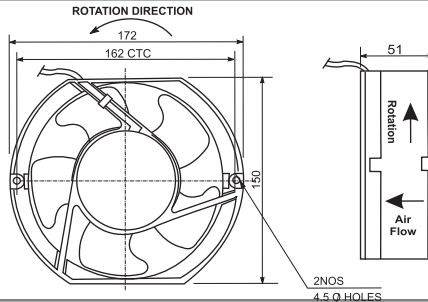

AIR PERFORMANCE

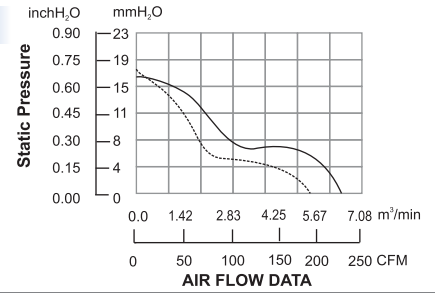

DIMENSION

6" SQUARE FAN
 172 x 172 x 55 mm

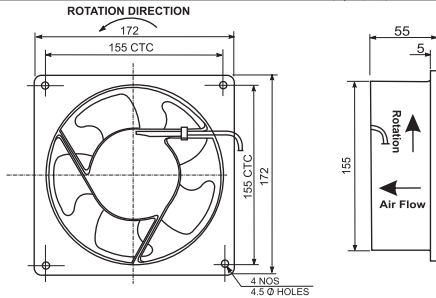

AIR PERFORMANCE

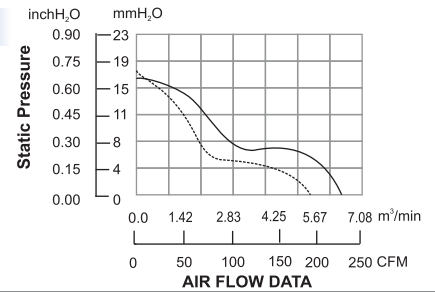

DIMENSION

8" SQUARE FAN
 220 x 220 x 60 mm

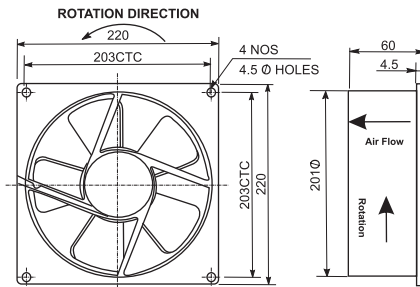

AIR PERFORMANCE

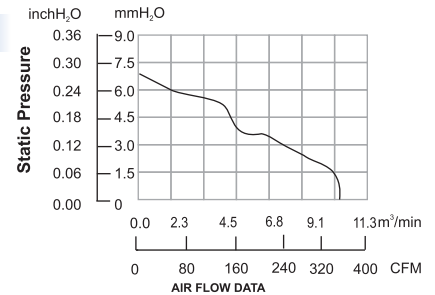

DIMENSION

8" ROUND FAN
 220 Ø x 60 mm

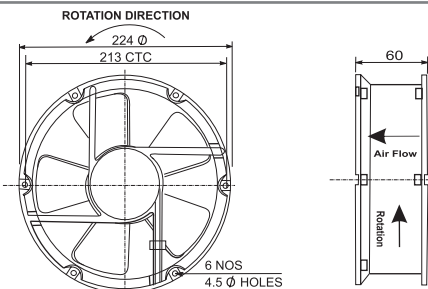

AIR PERFORMANCE

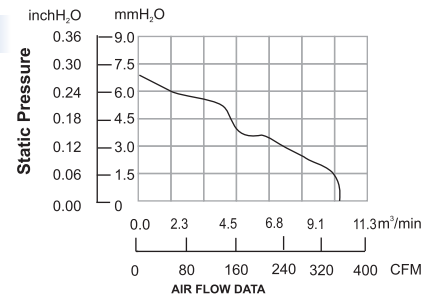

ALL ABOVE DIMENSIONS ARE IN mm



NEOTECHTM

The True Engineers

CONNECT

SHREE POOJA INDUSTRIES

Regd. Off.:

16, 2nd Floor, Ganesh Industrial Estate,
Behind Virwani Ind. Estate,
Goregaon (E), Mumbai - 400 063. (INDIA)

Telephone : +91 - 22 - 40033907

E-mail : neotechfans@gmail.com

Website : www.jainsoncontrols.com

- PRICES ARE EXCLUSIVE OF ALL TAXES & DUTIES
- WE RESERVE THE RIGHT TO CHANGE IN THE PRICE LIST
- ALL DISPUTES ARE SUBJECT TO MUMBAI JURISDICTION